

FRONT ELEVATION AS EXISTING (1:100)

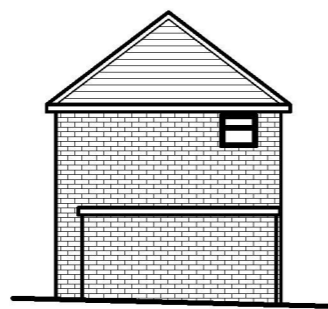

SIDE ELEVATION AS EXISTING (1:100)

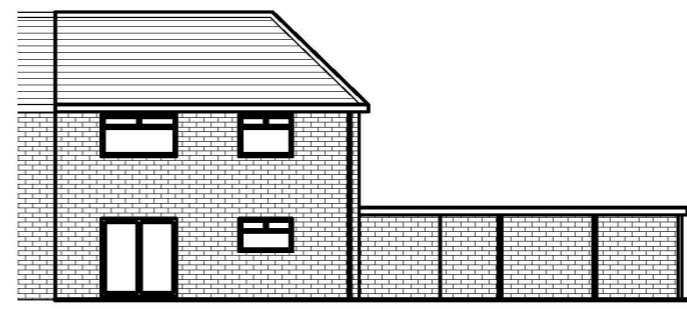

REAR ELEVATION AS EXISTING (1:100)

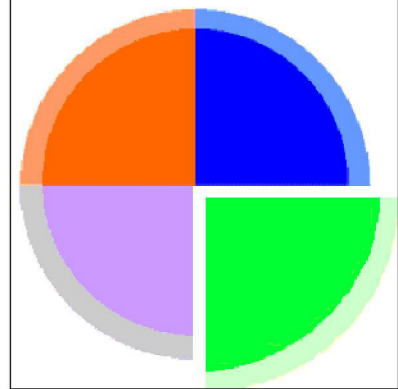

FRONT ELEVATION AS PROPOSED (1:100)



SIDE ELEVATION AS PROPOSED (1:100)

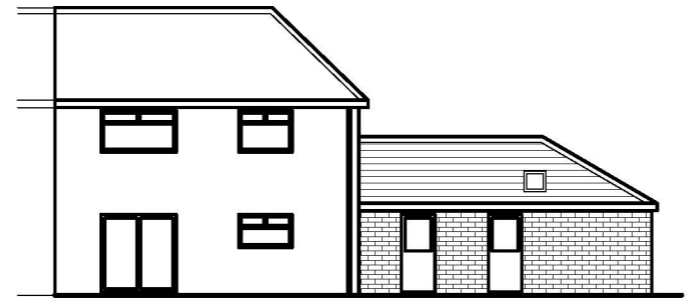

REAR ELEVATION AS PROPOSED (1:100)

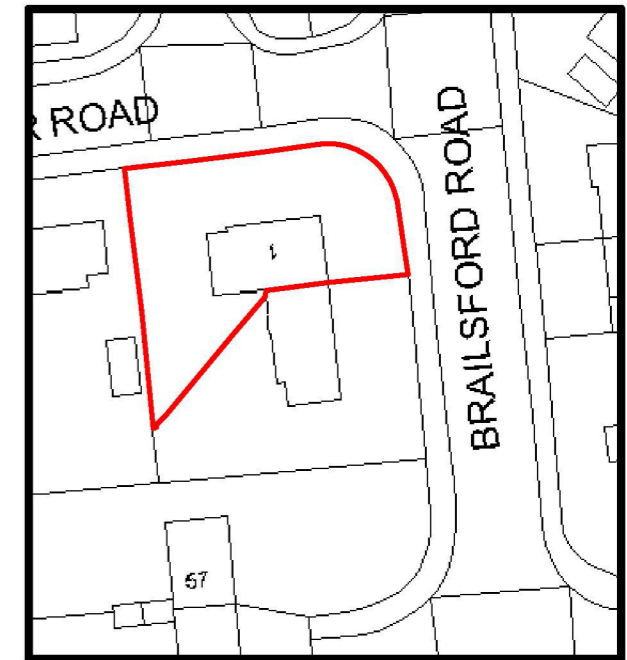

PLAN VIEW (1:500)

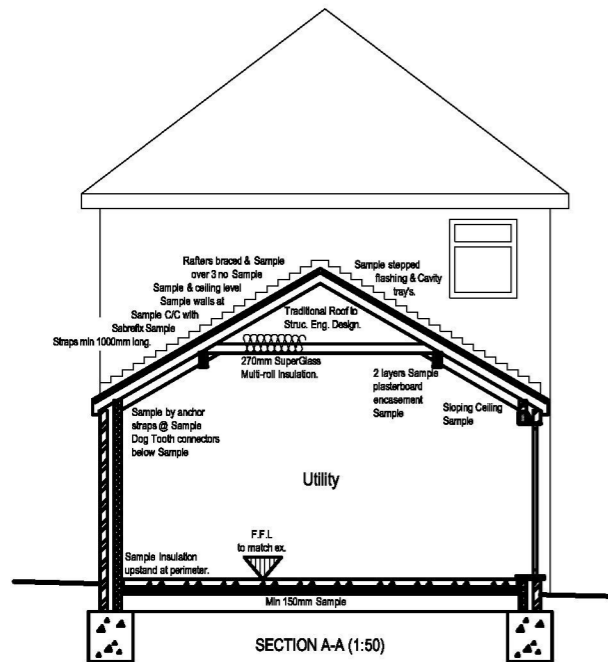

SECTION A-A (1:50)

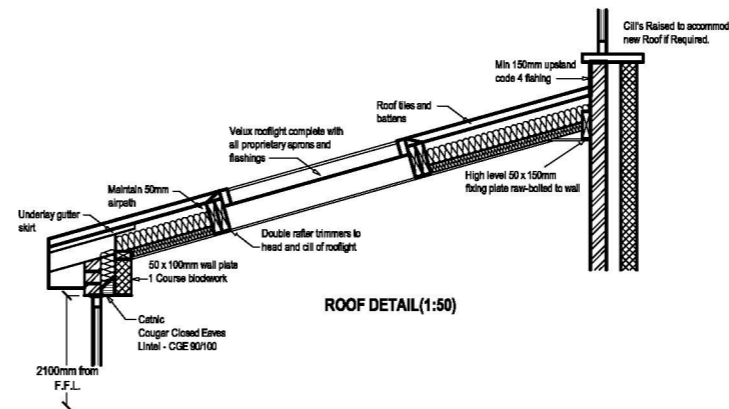

ROOF DETAIL (1:50)

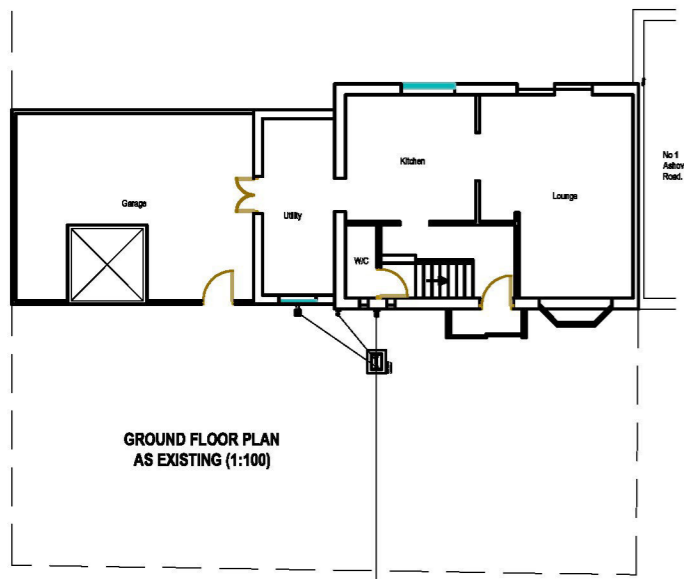

GROUND FLOOR PLAN AS EXISTING (1:100)

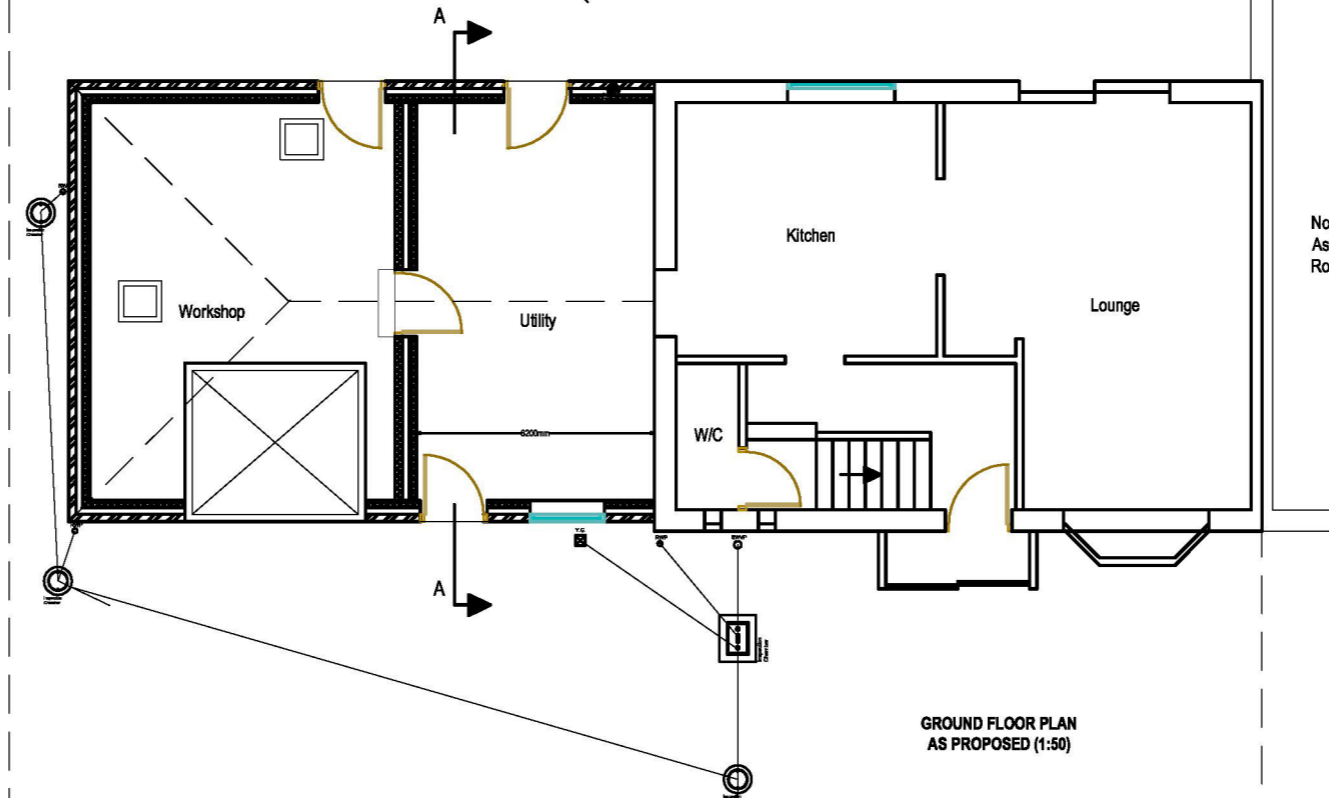

GROUND FLOOR PLAN AS PROPOSED (1:50)

Extension Design Plans Architectural Services

The Planning Permission and
Building Regulations Design Specialists.

www.extension-design-plans.co.uk

CLIENT:
SAMPLE

PROJECT:
Single storey side
extension.

DWG NUMBER:
443 - 1

REVISION:
A

PURPOSE:
Planning Application

DATE:
Jan 2012

1/100 Scale
A3 Plot
0 1000mm